

TEST REPORT No : 06534-01

DATE OF ISSUE : 22 November 2023

Page 1 of 11

BS EN ISO 10534-2:2001

**ACOUSTICS – DETERMINATION OF SOUND ABSORPTION COEFFICIENT AND
IMPEDANCE IN IMPEDANCE TUBES – Part 2: Transfer Function Method**

CLIENT: Camira Fabrics Limited
The Watermill
Wheatley Park
Mirfield
West Yorkshire
WF14 8HE

JOB NUMBER: 06534

MANUFACTURER: Client

MODEL: RePlay Zero, Batch: 531484, Colour: Move 21

DATE ORDER RECEIVED: 08 November 2023

DATE OF TEST: 22 November 2023

Signed: 
S M Furlong
Specialist Acoustics Technician

Approved: 
Claire Lomax
Quality Manager

1 TEST SAMPLES

1.1 Description of Test Samples

Test Reference: 6534-0001

Sample Reference: RePlay Zero, Batch: 531484, Colour: Move 21

Sample Description: Woven Fabric over Melamine Foam

Four samples cut to 100 mm diameter and 1.0 mm thickness, and four samples cut to 29 mm and 1.1 mm thickness were submitted for testing. The samples were mounted loose, over a (nominal) 100 mm layer of melamine foam*, in the large and small sample holders of the impedance tube respectively.

Large mass per unit area: 0.4 kg/m²

Small mass per unit area: 0.4 kg/m²

Visible Layers: None

**The results from the sound absorption coefficient tests for the uncovered melamine foam are included in an appendix, at the end of this report.*

1.2 Photograph

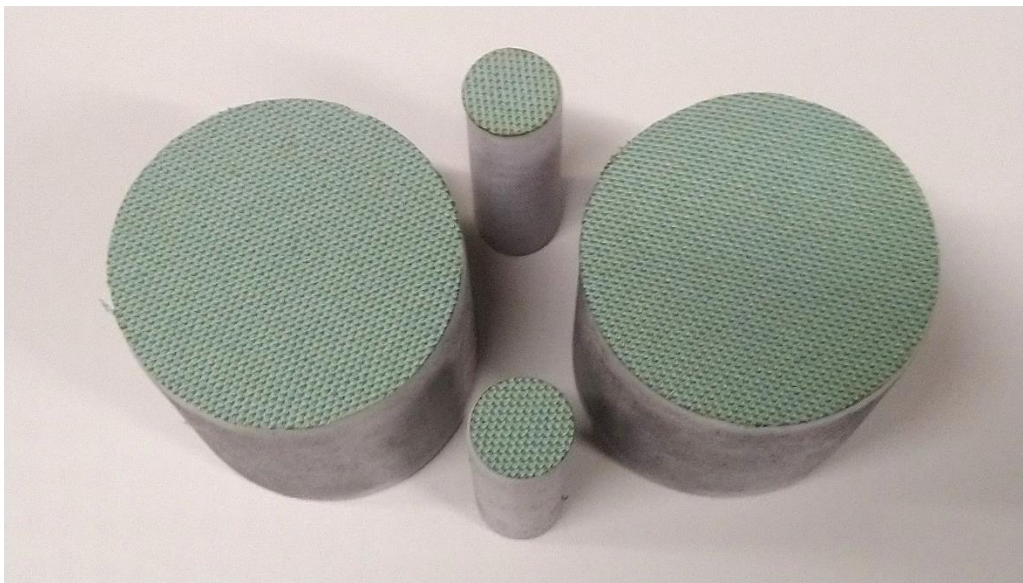

2 DESCRIPTION OF TEST PROCEDURE

2.1 Description of Test Equipment

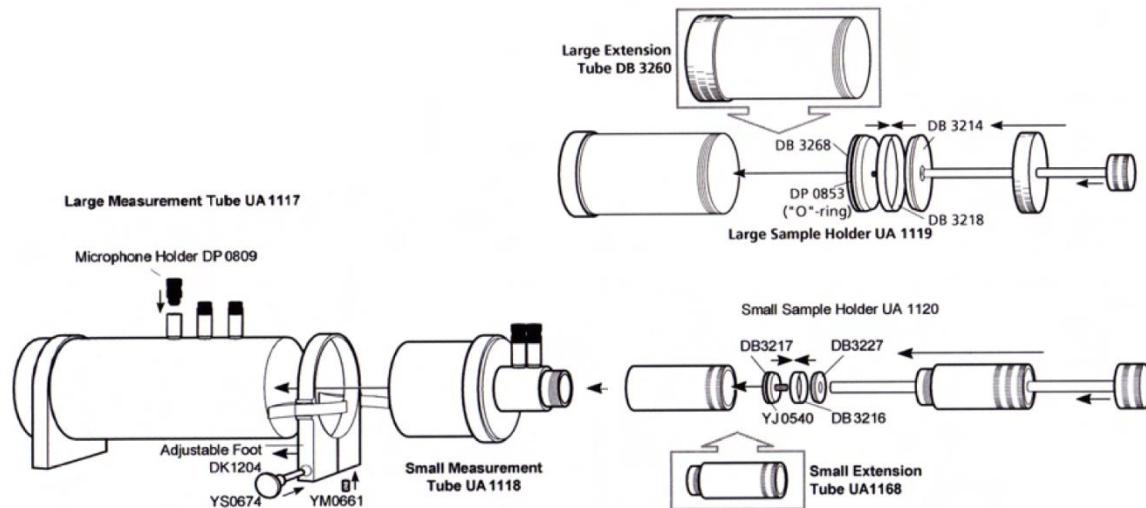

Figure 1: Brüel and Kjær Type 4206 Impedance Tube Components

The samples were tested in the Brüel and Kjær Type 4206 Impedance Tube, which has adapters for both large and small sample holders. When using the small sample adaptation there are five possible $\frac{1}{4}$ inch microphone slots, with a 20 mm spacing between the two microphone positions used during this test. When using the large sample adaptation there are three possible $\frac{1}{4}$ inch microphone slots, with a 100 mm spacing between the two microphone positions used in this test. Both microphones have a polarisation voltage of 200 V.

The small sample holder contains a plunger capable of adjusting the sample position and providing an air gap to the rear of the sample if desired. The large sample holder has a fitting device to ensure the sample remains flush to the edge of the holder.

The tube also contains a loudspeaker at one end with its own frequency-weighting unit capable of providing a high-pass filter (for high frequency measurements), linear filter, and low pass filter (for extra accuracy in low frequency measurements). The loudspeaker has a diameter of 80 mm and nominal impedance of 4 Ω . The maximum rated input power to the loudspeaker is 10 W (at 20 °C) so voltage supplied to the loudspeaker is kept at 1.141 V during the test. The default filter used for the loudspeaker is linear.

The tube is connected to its accompanying Brüel and Kjær PULSE Front-End Analyser, which works as a real-time analyser with a pre-installed software package to control the analyser from a PC and perform the measurement calculations.

2.2 Test Procedure

The test procedure follows that detailed in BS EN ISO 10534-2. The PULSE Front-End analyser is connected to a PC via a LAN cable, and the ¼ inch microphones connected to the LEMO inputs on the analyser. The analyser is also connected to an amplifier. The loudspeaker is powered via the amplifier, with a voltmeter also connected to ensure correct input signal to the loudspeaker. The large/small sample holder is attached to the tube.

Prior to measurement, the atmospheric pressure, temperature and humidity are recorded, the microphones are calibrated through the analyser software, the signal-to-noise ratio is calculated, and a Transfer-Function calibration is also performed.

The large/small sample holder is removed and the sample placed in the holder and is checked to ensure it is flush to the edge of the holder, and no air gaps appear around the diameter of the sample. A broadband random noise is generated by the loudspeaker and the incident and reflected components of the sound field are measured by the two microphones in their appropriate positions. This is repeated with the microphone positions interchanged. Three frequency response functions from the measurements are then used by the software to calculate the reflection and absorption coefficients.

2.3 Calculations

The normal incidence absorption coefficient (α) is calculated using the following equation:

$$\alpha = 1 - |R|^2$$

Where,

R is complex reflection coefficient;

$$R = \left(\frac{H_{12} - H_i}{H_r - H_{12}} \right) e^{2jk_0x_1}$$

Within that,

H_{12} is the complex acoustic transfer function between the two microphone signals;

$$H_{12} = H_r + jH_i$$

And,

j is the complex integer equivalent to $\sqrt{-1}$;

H_i is the incident component frequency response function (the complex part of H_{12});

H_r is the reflected component frequency response function (the real part of H_{12});

k_0 is the wavenumber in radians per metre;

x_1 is the distance between the sample and the further microphone location in metres.

The two microphone transfer function method described in BS EN ISO 10534-2:2001 makes the assumption on plane wave propagation within the tube with no mean flow and negligible losses or absorption along the tube wall. Specifications of the Brüel and Kjær Type 4206 Impedance Tube as provided by the manufacturer can be made available on request.

3 EQUIPMENT

	Departmental Record No
• Brüel and Kjær Type 4206 Impedance Tube	2681869
• Brüel and Kjær PULSE Front-End Generator	2477213/ PULSE N.2
• Dial-A-Watt Power Amplifier	129003364
• Two Brüel and Kjær ¼ Inch Condenser microphones (attached by tape to their LEMO cables)	2677390 & 2677391
• Calibrator	1795258
• Model DA212 AVO avometer	129006085
• Four Banana-Banana cables	
• BNC-BNC cable	
• LAN cable	
• Laptop or PC supporting the B&K PULSE Software, with accompanying PULSE Dongle	

4 RESULTS

The random incidence sound absorption coefficients are given in the tables overleaf.

Large sample thickness	1.0 mm	
Large sample area	0.007854 m ²	
Large sample mass per unit area	0.4 kgm ⁻²	
Small sample thickness	1.1 mm	
Small sample area	0.000661 m ²	
Small sample mass per unit area	0.4 kgm ⁻²	
	Large Sample	Small Sample
Temperature [°C ± 0.3]	18.8	19.3
Rel. humidity [% ± 3.0]	41.0	40.6
Atm. Pressure [kPa ± 0.2]	102.5	102.5

The results here presented relate only to the items tested and described in this report.

BS EN ISO 10534-2:2001 Acoustics - Determination of Sound Absorption Coefficient in Impedance Tubes; Transfer Function Method

Client: Camira Fabrics Limited
 Product Identification: RePlay Zero, Batch: 531484, Colour: Move 21
 Description of Sample: Woven Fabric over Melamine Foam
 Curing Time: Not Applicable

Large Sample [50-1600Hz]

Temperature: 18.8 °C
 Humidity: 41.0 %
 Atmos. Pressure: 102.5 kPa
 Diameter: 100.0 mm
 Thickness: 1.0 mm
 Mass per Unit Area: 0.4 kg/m²
 Condition: Satisfactory

Small Sample [500-5000Hz]

Temperature: 19.3 °C
 Humidity: 40.6 %
 Atmos. Pressure: 102.5 kPa
 Diameter: 29.0 mm
 Thickness: 1.1 mm
 Mass per Unit Area: 0.4 kg/m²
 Condition: Satisfactory

Normal incidence sound absorption coefficient, α_s

Frequency [Hz]	α_s Large [50-1600]	α_s Small [500-5000]	α_s Total [50-5000]
50	0.09	--	0.09
63	0.11	--	0.11
80	0.18	--	0.18
100	0.26	--	0.26
125	0.36	--	0.36
160	0.52	--	0.52
200	0.68	--	0.68
250	0.81	--	0.81
315	0.90	--	0.90
400	0.95	--	0.95
500	0.95	0.95	0.95
630	0.94	0.96	0.95
800	0.89	0.94	0.92
1000	0.78	0.90	0.84
1250	0.81	0.88	0.84
1600	0.85	0.88	0.87
2000	--	0.88	0.88
2500	--	0.83	0.83
3150	--	0.80	0.80
4000	--	0.82	0.82
5000	--	0.79	0.79

Test reference: 6534-0001

Date of Test: 22 November 2023

University of Salford, School of Computing Science & Engineering

BS EN ISO 10534-2:2001 Acoustics - Determination of Sound Absorption Coefficient in Impedance Tubes; Transfer Function Method

Client: Camira Fabrics Limited
 Product Identification: RePlay Zero, Batch: 531484, Colour: Move 21
 Description of Sample: Woven Fabric over Melamine
 Curing Time: Not Applicable

Large Sample [50-1600Hz]

Temperature: 18.8 °C
 Humidity: 41.0 %
 Atmos. Pressure: 102.5 kPa
 Diameter: 100.0 mm
 Thickness: 1.0 mm
 Mass per Unit Area: 0.4 kg/m²
 Condition: Satisfactory

Small Sample [500-5000Hz]

Temperature: 19.3 °C
 Humidity: 40.6 %
 Atmos. Pressure: 102.5 kPa
 Diameter: 29.0 mm
 Thickness: 1.1 mm
 Mass per Unit Area: 0.4 kg/m²
 Condition: Satisfactory

Normal incidence sound absorption coefficient, α_s

Frequency [Hz]	α_s [50-5000]
50	0.09
63	0.11
80	0.18
100	0.26
125	0.36
160	0.52
200	0.68
250	0.81
315	0.90
400	0.95
500	0.95
630	0.95
800	0.92
1000	0.84
1250	0.84
1600	0.87
2000	0.88
2500	0.83
3150	0.80
4000	0.82
5000	0.79

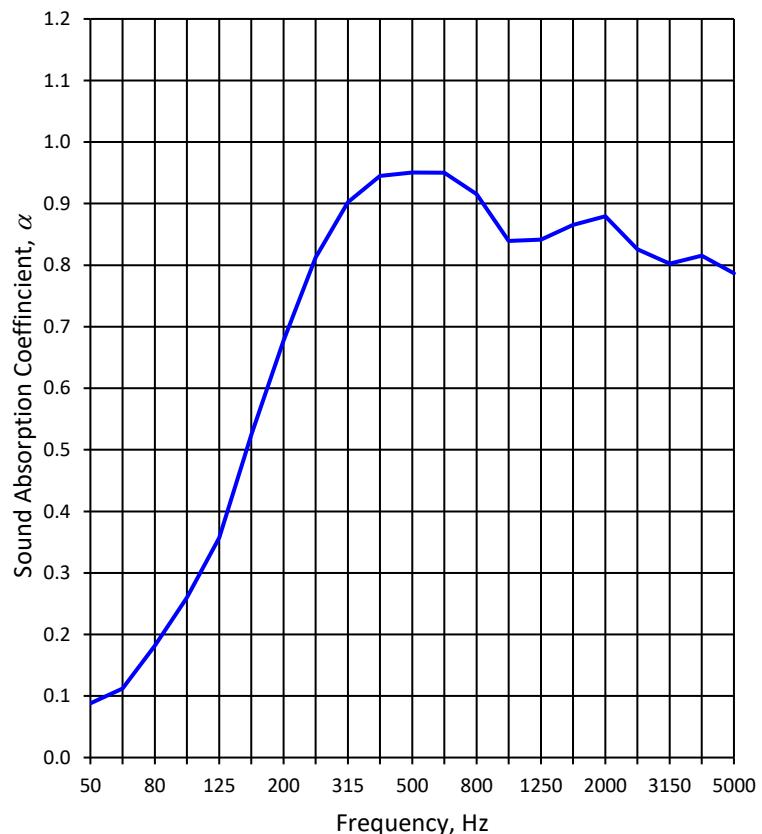

Signed: *S. M. Farooq*

Test reference: 6534-0001

Date of Test: 22 November 2023

University of Salford, School of Computing Science & Engineering

5 APPENDIX**BS EN ISO 10534-2:2001 Acoustics - Determination of Sound Absorption Coefficient in Impedance Tubes; Transfer Function Method**

Client: Camira Fabrics Limited
 Product Identification: Nominal 100 mm Melamine Foam
 Description of Sample: Foam
 Curing Time: Not Applicable

Large Sample [50-1600Hz]

Temperature: 18.8 °C
 Humidity: 41.0 %
 Atmos. Pressure: 102.5 kPa
 Diameter: 100.0 mm
 Thickness: 103.3 mm
 Mass per Unit Area: 0.9 kg/m²
 Condition: Satisfactory

Small Sample [500-5000Hz]

Temperature: 19.3 °C
 Humidity: 40.6 %
 Atmos. Pressure: 102.5 kPa
 Diameter: 29.0 mm
 Thickness: 101.0 mm
 Mass per Unit Area: 0.9 kg/m²
 Condition: Satisfactory

Normal incidence sound absorption coefficient, α_s

Frequency [Hz]	α_s <i>Large</i> [50-1600]	α_s <i>Small</i> [500-5000]	α_s <i>Total</i> [50-5000]
50	0.09	--	0.09
63	0.12	--	0.12
80	0.17	--	0.17
100	0.22	--	0.22
125	0.29	--	0.29
160	0.40	--	0.40
200	0.52	--	0.52
250	0.63	--	0.63
315	0.74	--	0.74
400	0.83	--	0.83
500	0.88	0.91	0.90
630	0.90	0.96	0.93
800	0.92	0.98	0.95
1000	0.95	0.98	0.97
1250	0.94	0.96	0.95
1600	0.95	0.95	0.95
2000	--	0.98	0.98
2500	--	0.99	0.99
3150	--	0.98	0.98
4000	--	1.00	1.00
5000	--	0.99	0.99

Test reference: 6534-0010

Date of Test: 22 November 2023

University of Salford, School of Computing Science & Engineering

BS EN ISO 10534-2:2001 Acoustics - Determination of Sound Absorption Coefficient in Impedance Tubes; Transfer Function Method

Client: Camira Fabrics Limited
 Product Identification: Nominal 100 mm Melamine Foam
 Description of Sample: Foam
 Curing Time: Not Applicable

Large Sample [50-1600Hz]

Temperature: 18.8 °C
 Humidity: 41.0 %
 Atmos. Pressure: 102.5 kPa
 Diameter: 100.0 mm
 Thickness: 103.3 mm
 Mass per Unit Area: 0.9 kg/m²
 Condition: Satisfactory

Small Sample [500-5000Hz]

Temperature: 19.3 °C
 Humidity: 40.6 %
 Atmos. Pressure: 102.5 kPa
 Diameter: 29.0 mm
 Thickness: 101.0 mm
 Mass per Unit Area: 0.9 kg/m²
 Condition: Satisfactory

Normal incidence sound absorption coefficient, α_s

Frequency [Hz]	α_s [50-5000]
50	0.09
63	0.12
80	0.17
100	0.22
125	0.29
160	0.40
200	0.52
250	0.63
315	0.74
400	0.83
500	0.90
630	0.93
800	0.95
1000	0.97
1250	0.95
1600	0.95
2000	0.98
2500	0.99
3150	0.98
4000	1.00
5000	0.99

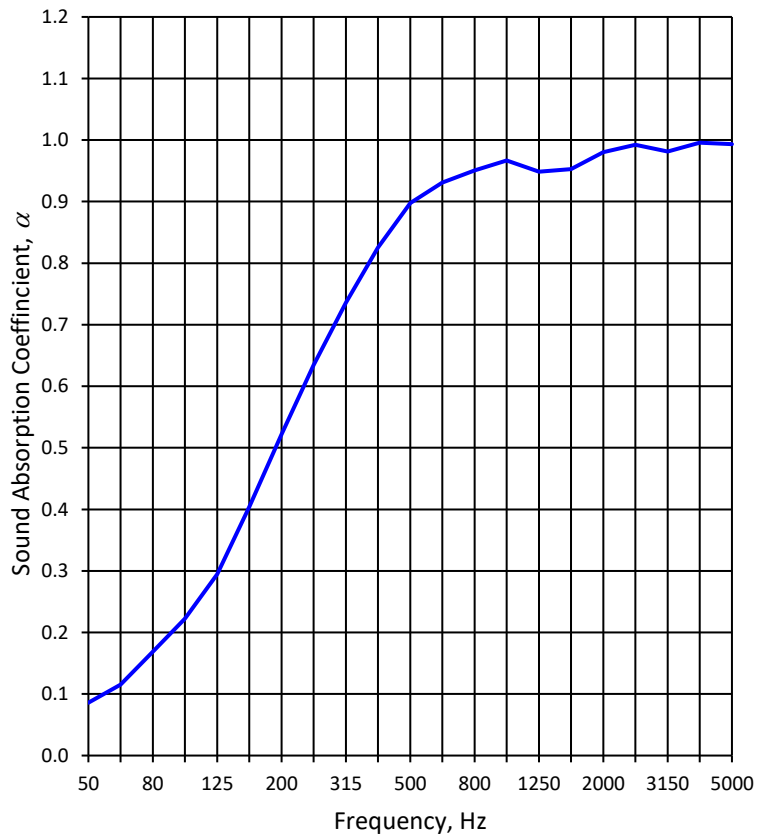

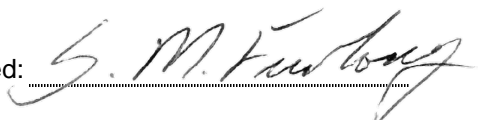
Signed: 

Test reference: 6534-0010

Date of Test: 22 November 2023

University of Salford, School of Computing Science & Engineering